

NSTT
GmbH



Ankerbohrgerät

BERETTA T155

 **BERETTA**[®]
Vertragshändler

NEUF
Spezialtiefbautechnik

- Beratung
- Vermietung
- Verkauf
- Service

T155



BERETTA®

Hydraulic Drilling Rigs

EN	IT	FR	Unità potenza - Power pack - Unités puissance - Силовой блок - Unidad potencia - Leistungseinheit	RU	ES	DE
Diesel engine						дизельный двигатель
Motore Diesel			DEUTZ STAGE 3A - TIER 3			Motor Diesel
Moteur Diesel				DEUTZ STAGE 3B-TIER4I.		Dieselmotor
Engine power						мощность двигателя
Potenza motore			129KW - 173 HP			Potencia motor
Puissance moteur			2300 rpm	115 KW - 154 HP		Motorleistung
				2300 rpm		
Oil tank						масляной бак
Sebatoio olio			320 L - 83,2 gal			Tanque aceite
Réservoir d'huile						Öltank
Crawler - Carro cingolato - Chenilles - гусеница - Orugas - Raupenwagen						
Fixed width						макс. ширина гусенич. Хода
Larghezza fissa			1900 mm - 74,78 in			Anchura max
Largeur fiss			opt 2100 mm - 82,67 in			Max. Breite
Shoes width						широта башмака гусеницы
Larghezza pattini			400 mm - 15,6 in			Zapatos anchos
Larghezza patins						Breite Kufen
Ground bearing pressure						давление на грунт
Pressione suolo			6,2 N/cm ² - 8,8 PSI			Presion suelo
Pression au sol						Bodendruck
Speed max.						максимальная скорость
Velocità max.			3 Km/h - 1,86 mph			Velocidad max.
Vitesse max.						Max. Geschwindigkeit
Gradeability max.						макс. преодолеваемый склон
Pendenza max.			55%			Pendiente max.
Pente max.						Max. Neigung
Mast - Mat - Мачта - Mestil						
Stroke						ход вращателя
Corsa utile			4000 mm - 161 in			Carrera
Course utile			6300 mm - 248 in			Arbeitshub
Pull-push						макс. тяговое усилие
Tiro-spinta			90 KN - 19841 lb			Tiro
Traction						Max. Zug/Schub
Rising speed						скорость подъема
Velocità risalita			26 m/min			Velocidad remonte
Vitesse de remontée						Anstiegs geschwindigkeit
Double Clamp - Doppia Morsa - Double Mors - двойные тиски - Doble Mordaza - Doppelspannschelle						
Blocking diameter						диаметр захвата тисков
Diametro bloccaggio			mm. 40 - 219 / 324 / 435			Diametro bloque
Diamètre blocage			in 1,57 - 8,62 / 12,75 / 17,12			Durchmesser Sperre
Clamping force						усилие зажима
Forza chiusura			160 KN - 35969 lb			Fuerza cierre
Force fermeture			205 KN - 46085 lb			Schließkraft
Break-out torque						момент развинчивания
Coppia svitamento			26 KN - 19160 lb			Par desenroscado
Couple deserrage			52 KN - 38320 lb			Anzugmoment
Weight - Peso - Poids - Bec - Gewicht						
12 - 14 Ton / 26455 - 30864 lb						



Options - Opzioni - Options - Опции - Opciones - Extras

Hydraulic winch	Argano idraulico	Treuil Hydr.	лебедка	Calbrestante	Seilwinde
Lubricator DTH	Oliatore DTH	Grisseur DTH	масло-посторонник	Lubricador DTH	Schmervorrichtung
Top hammer	Martello idraulico	Marteau hydr.	гидравлоударника	Martillo hidráulico	Top hammer
Remote control	Radiocontrol	Radiocommande	радиоуправление	Radio	Fernbedienung
Chuck hydraulic	Mandrin idraul.	Chuck hydraulique	гидро гидравлический	Chuck hydr.	Spannkopf Hydr.
Extension Jet	Prolunga Jet	Extension Jet	расширение струи	Extension Jet	Meißverlängerung Jet

Pumps	Pompe	Pumpes	Насос	Bombas	Pumps
Clean water	Acqua pulita	à eau	для чистой воды	Agua	Wasser
Screw mud	Fango	à boue à vis	винтовой грязевой	De loto	Schlammpumpe
Triple cement	Cemento	Triplex boue ciment	цементный грязевой	Cemento	Zementpumpe
Simple ejection	Scarabozze	Injection échantillon	исследовательский	Scarabozze	Bohrpumpe

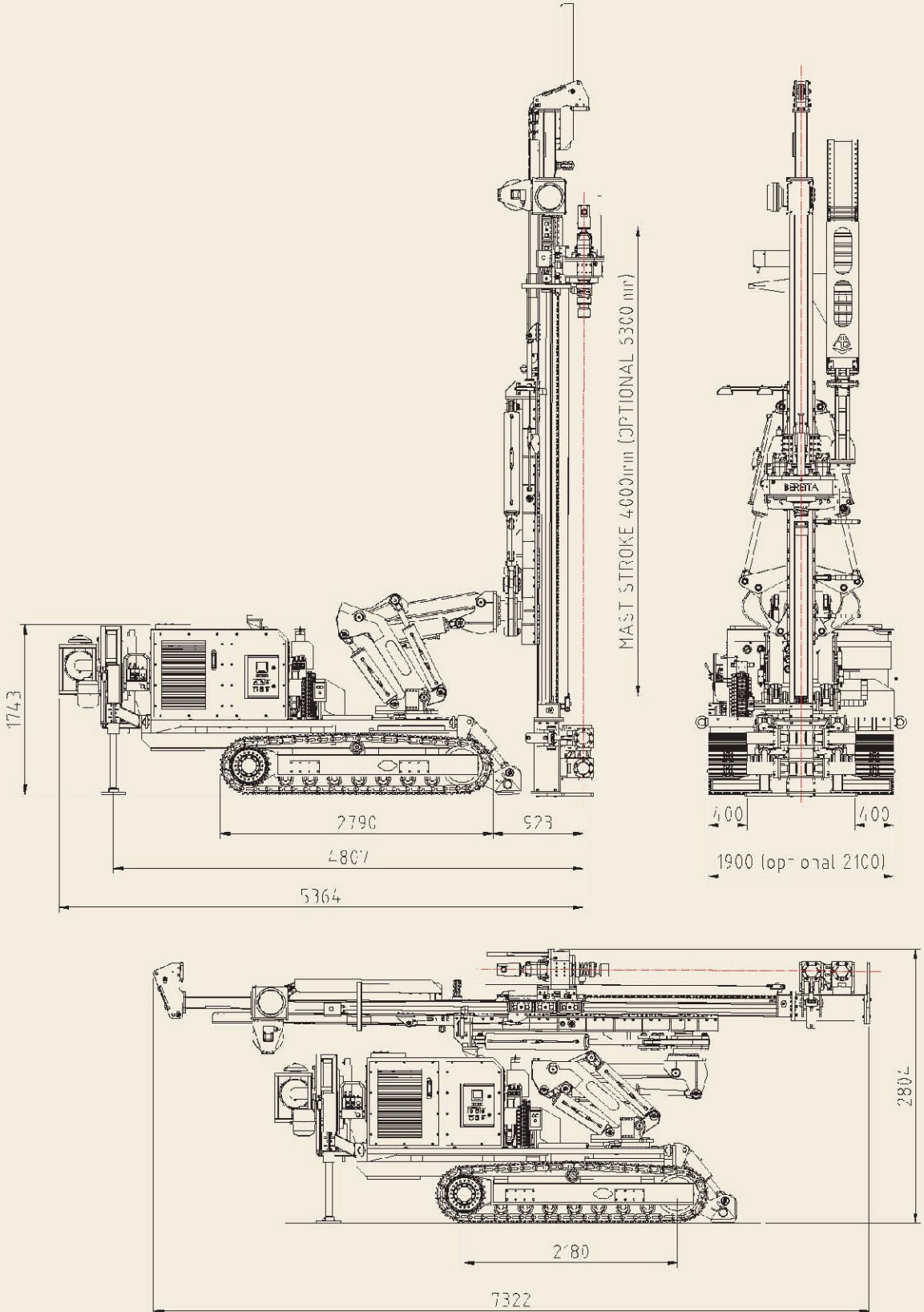

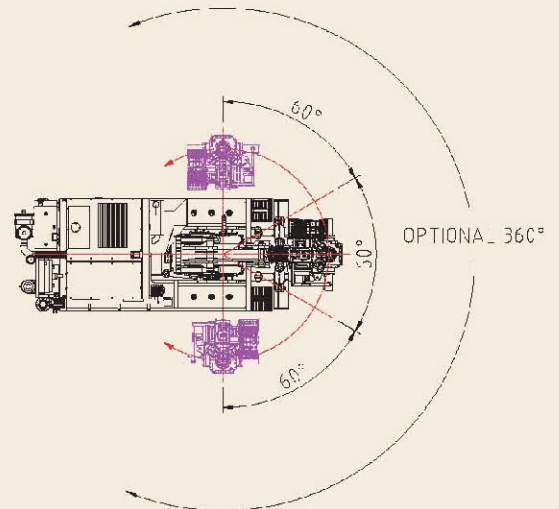
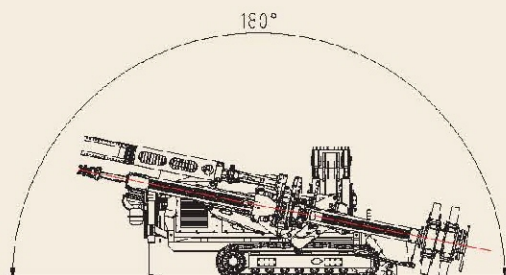
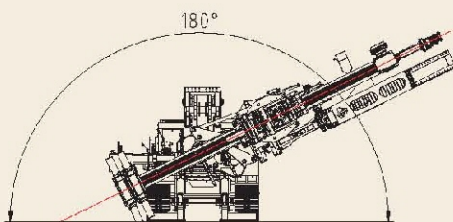
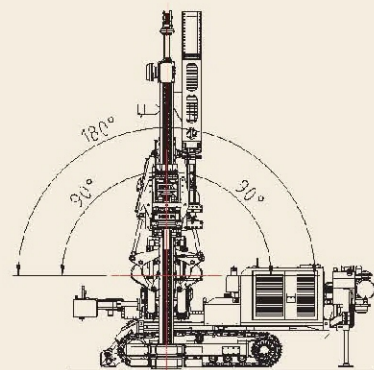
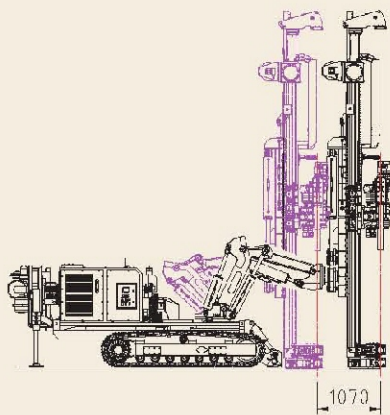
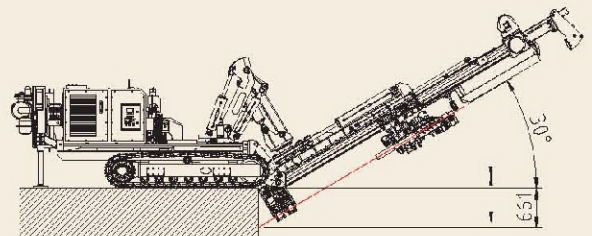
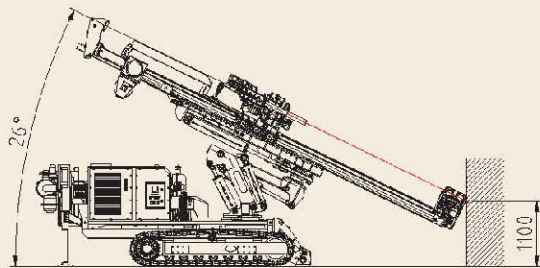
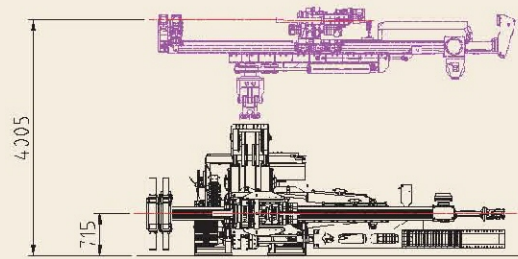
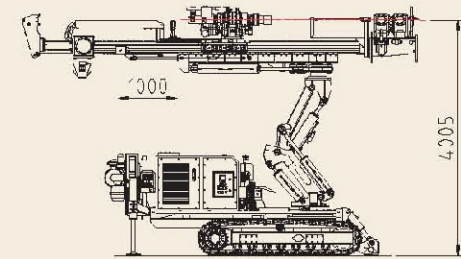

54-1500 (2 or 3 speed)



57-4V (4 speeds)

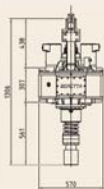

55-8V (8 speeds)

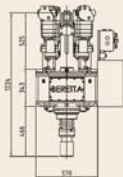

54-1500 2V Rotary Head									
Speed	A			B			C		
	daNm	lb ft	RPM	daNm	lb ft	RPM	daNm	lb ft	RPM
1°	1450	10701	35	1250	9255	50	1100	8118	55
2°	725	5351	70	625	4813	100	550	4059	110

54-1500 3V Rotary Head												
Speed	A			B			C			D		
	daNm	lb ft	RPM	daNm	lb ft	RPM	daNm	lb ft	RPM	daNm	lb ft	RPM
1°	2300	16974	23	1520	7232	35	1150	5901	45	755	4576	70
2°	1150	8487	46	760	5609	70	575	4244	90	377	2782	140
3°	720	5314	75	450	3616	115	360	2900	145	225	2288	234

Max oil feed - Portata Max. - Max. Flux huile - Маскк. Расход масла - Max. Flujo aceite -Max. Ölmenge
160 l/min - 42,0 gal/min

Max working pressure - Pressione max. - Pression Max. - Маскк. Давление - Presión Max - Max. Druck
250 bar - 3555 PSI

Inside Diameter JET grouting - Diametro interno JET grouting - Внутренний диаметр струйной цементации
95 mm - 3,7 in

Total Weight - Peso - Poids - Вес - Gewicht
2V 455 Kg - 1004 lb / 3V 480 Kg - 1058 lb

57-4V Rotary Head															
Speed	A			B			C			D			E		
	daNm	lb ft	RPM	daNm	lb ft	RPM	daNm	lb ft	RPM	daNm	lb ft	RPM	daNm	lb ft	RPM
1°	1742	12858	25	1445	10884	30	1132	8354	39	896	8812	50	894	5122	64
2°	868	6406	50	722	5328	60	566	4177	78	446	3306	100	347	2561	129
3°	391	2886	113	361	2664	137	255	1882	174	224	1853	220	156	1151	286
4°	195	1439	226	180	1328	274	127	937	349	112	827	440	78	576	572

Max oil feed - Portata Max. - Max. Flux huile - Маскк. Расход масла - Max. Flujo aceite -Max. Ölmenge
125 l/min - 33,0 gal/min

Max working pressure - Pressione max. - Pression Max. - Маскк. Давление - Presión Max - Max. Druck
250 bar - 3555 PSI

Inside Diameter JET grouting - Diametro interno JET grouting - Внутренний диаметр струйной цементации
62 mm - 2,44 in

Weight - Peso - Poids - Вес - Gewicht
365 Kg - 804 lb

55-8V Rotary Head									
	A			B			C		
	daNm	lb ft	RPM	daNm	lb ft	RPM	daNm	lb ft	RPM
1°	1894	13978	30	1587	11712	36	1389	10251	42
2°	1233	9100	47	1182	8576	50	1116	8236	52
3°	1102	8133	53	795	5867	74	597	4406	97
4°	862	6362	68	555	4086	106	357	2835	164
5°	440	3247	132	370	2731	156	325	2389	180
6°	250	1845	239	241	1779	243	231	1705	260
7°	200	1476	290	129	952	453	84	620	704
8°	134	989	437	86	635	680	55	406	1050

Max oil feed - Portata -
160 l/min - 42,0 gal/min

Max working pressure - Pressione max
230 bar - 3267 PSI

Inside Diameter JET grouting - Diametro interno JET grouting
92 mm - 3,62 in

Weight - Peso - Poids - Вес - Gewicht
510 Kg - 1120 lb

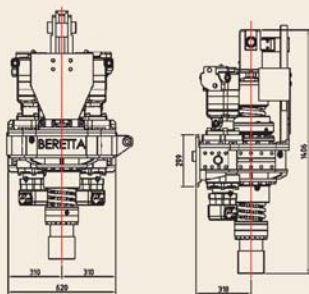
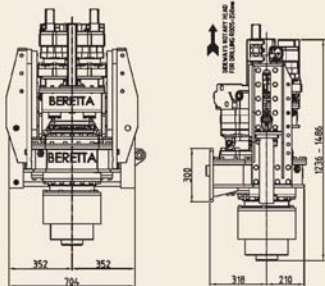
T155*Rotary head - Testa rotazionale - Tête rotation - Брауэртель - Cabeza rotacion - Rotationskopf***RMS 515-F****RMS 415 (double head)**

RMS 515-F Rotary Head									
	A			B			C		
Speed	daNm	lb ft	RPM	daNm	lb ft	RPM	daNm	lb ft	RPM
1°	3020	22288	18	2560	18893	20	2010	14834	26
2°	1510	11144	36	1280	9446	40	1005	7417	52
3°	950	7011	60	730	5387	70	600	4428	90
Max oil feed - Portata Max. - Max. Flux huile - Маскс. Расход масла - Max. Flujo aceite -Max. Ölmenge									
160 l/min - 41,6 gal/min									
Max working pressure - Pressione max. - Pression Max. - Маскс. Давление - Presión Max - Max. Druck									
250 bar - 3270 PSI									
Weight - Peso - Poids - Bec - Gewicht									
600 Kg - 1322 lb									

RMS 415 Double Rotary Head															
ROTARY HEAD FOR CASINGS															
	A			B			C								
Speed	daNm	lb ft	RPM	daNm	lb ft	RPM	daNm	lb ft	RPM						
1°	3000	22140	18	2600	19188	20	2000	14760	26						
2°	1500	11070	36	1400	10332	40	1000	7380	52						
2°	970	7159	60	750	5535	75	600	4428	90						
Max oil feed - Portata 160 l/min - 42,3 gal/min															
Max working pressure - Pressione max. 230 bar - 3271 PSI															
Rotary Head for Inner Rods															
	A			B			C			D			A		
Speed	daNm	lb ft	RPM	daNm	lb ft	RPM	daNm	lb ft	RPM	daNm	lb ft	RPM	daNm	lb ft	RPM
1°	936	6904	41	767	5657	51	610	2825	64	468	3452	82	374	2758	102
2°	468	3452	82	383	2825	102	305	4498	132	234	1726	164	187	1379	204
Max oil feed - Portata Max. - Max. Flux huile - Маскс. Расход масла - Max. Flujo aceite -Max. Ölmenge															
115 l/min - 30,0 gal/min															
Max working pressure - Pressione max. - Pression Max. - Маскс. Давление - Presión Max - Max. Druck															
210 bar - 2987 PSI															
Total Weight - Peso - Poids - Bec - Gewicht															
720 Kg - 1587 lb															





BERETTA®

Hydraulic Drilling Rigs



Beretta Alfredo s.r.l.

20847 BUSANA IN BRINZANA (MI) - ITALIA - Via Vignarolo, 10
Tel. +39 (0)362 99 53 90 r.a. - Fax +39 (0)362 99 57 06
www.berettaalfredo.it - e-mail: info@berettaalfredo.it



www.icm.it





Bohrhämmer und VibroDrills

Als Nachfolgefirma der Spezialtiefbausparte von Thyssen-Krupp hat die **terra infrastructure GmbH** das Erbe der über 100-jährigen Erfahrung im Bergbau und der Bohrtechnik übernommen. Mit diesem fundierten Know-how und den patentierten Technologien hat terra infrastructure eine Serie neuer Bohrhämmer entwickelt sowie – weltneuheit – drei unterschiedlich große VibroDrills, die revolutionär in der Ankertechnik sind. Dank ihrer variablen Frequenzen und ihrer verstellbaren Unwuchten erreichen die VibroDrills schnelle Bohrfortschritte in nahezu allen Bodenarten und können in nahezu allen Bohrverfahren eingesetzt werden. In der Ankertechnik sind die VibroDrills nicht nur wegen ihrer Lärmreduktion revolutionär, beim Rückbau der Baustelle können die Anker wieder gezogen werden!

Als Vertriebspartner in Deutschland und Österreich bietet die NSTT GmbH die komplette terra infrastructure Produktpalette im Bereich der Bohrantriebe zum Kauf an. Dadurch ist sicher gestellt, dass für jedes Beretta-Gerät ein passender Bohrantrieb geliefert werden kann.



Bohrhämmer
in 10 verschiedenen
Ausführungen erhältlich

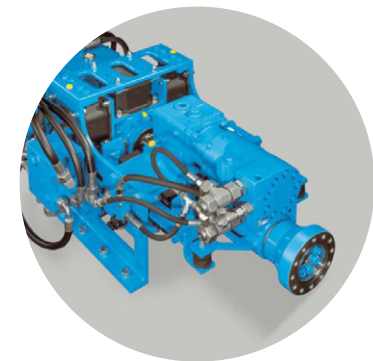

VibroDrills
in 3 verschiedenen
Größen erhältlich



NEUF
Spezialtiefbautechnik



Ihr Ansprechpartner:
Hubert Neuf
Geschäftsführer

NSTT GMBH
NEUF SPEZIALTIEFBAUTECHNIK
Industriering 12
63868 Großwallstadt

Tel.: +49 60 22- 70 91 92 - 0
Fax: +49 60 22- 70 91 92 - 20
Mail: info@nstt.de

www.nstt.de

Konstruktionsentwicklungen und Prozessverbesserungen können Aktualisierungen und Änderungen von Spezifikationen und Materialien ohne vorherige Ankündigung oder Haftung erforderlich machen. Die Abbildungen enthalten möglicherweise optionale Ausstattung und zeigen nicht alle möglichen Konfigurationen. Diese Angaben und die technischen Daten haben ausschließlich Informationscharakter. Irrtum und Druckfehler vorbehalten.